



MODEL

PKG series

205/305

ISSUE EMD-GU1789

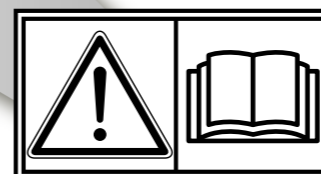

GB INSTRUCTIONS FOR USE

AR إرشادات الاستعمال

GB

AR



FUJI HEAVY INDUSTRIES LTD.

INDUSTRIAL PRODUCTS COMPANY

4-410 Asahi, Kitamoto-shi,
Saitama, 364-8511, Japan

Phone +81(48) 593-7798

Fax +81(48) 593-7946

Web site <http://www.fhi.co.jp/robin/>

PRINTED IN THAILAND
June 2003 KO-TA

3ZZ9990026

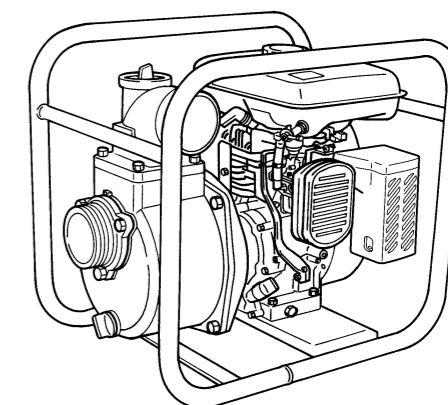

Robin Pump

FOREWORD

Thank you very much for purchasing a **ROBIN PUMP**.

This manual covers operation and maintenance of **ROBIN PUMP**.

All information in this publication is based on the latest product information available at the time of approval for printing. Please read this manual carefully before operating.

Please take a moment to familiarize yourself with the proper operation and maintenance procedures in order to maximize the safe and efficient use of this product.

Keep this owner's manual at hand, so that you can refer to it at any time.

Due to constant efforts to improve our products, certain procedures and specifications are subjected to change without notice.

When ordering spare parts, always give us the **MODEL**, **PRODUCTION NUMBER** and **SERIAL NUMBER** of your pump.

Please fill in the following blanks after checking the production number on your pump.

(Location of label is different depending on the pump specification.)

PROD No.									

SER No.				

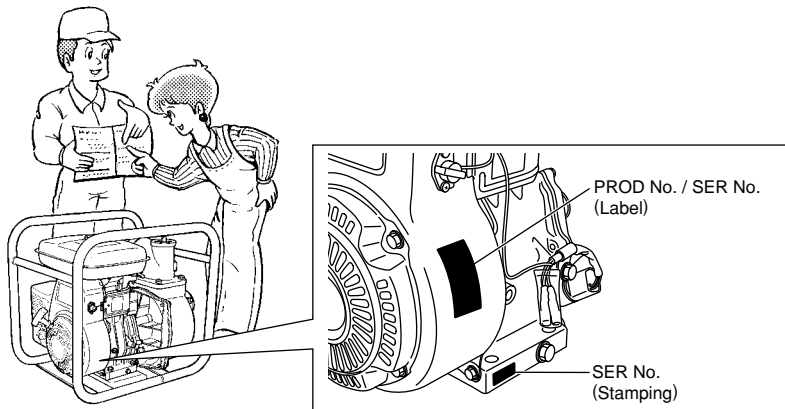

CONTENTS

	Page
1. SAFETY PRECAUTIONS	2
2. COMPONENTS	4
3. PRE-OPERATION FOR STARTING	5
4. OPERATING YOUR PUMP	5
5. MAINTENANCE	6
6. PREPARATIONS FOR STORAGE	8
7. OIL SENSOR INSTRUCTIONS (OPTIONAL)	8
8. EASY TROUBLESHOOTING	8
9. SPECIFICATIONS	9

NOTE Please refer to the illustrations on the back page of the front cover or back cover for Fig. **1** to **8** indicated in the sentence.

1. SAFETY PRECAUTIONS

Please make sure you review each precaution carefully.
Pay special attention to statement preceded by the following words.

⚠ WARNING “WARNING” indicates a strong possibility of severe personal injury or loss of life if instructions are not followed.

⚠ CAUTION “CAUTION” indicates a possibility of personal injury or equipment damage if instructions are not followed.

⚠ WARNING : EXHAUST PRECAUTIONS

- Never inhale exhaust gasses.
They contain carbon monoxide, a colorless, odorless and extremely dangerous gas which can cause unconsciousness or death.
- Never operate the pump indoors or in a poorly ventilated area, such as tunnel, cave, etc.
- Exercise extreme care when operating the pump near people or animals.
- Keep the exhaust pipe free of foreign objects.

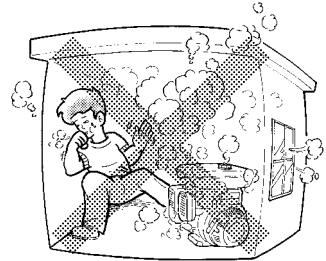

⚠ WARNING : REFUELING PRECAUTIONS

- Gasoline is extremely flammable and its vapors can explode if ignited.
- Do not refuel indoors or in a poorly ventilated area.
- Be sure to stop the pump prior to refueling.
- Do not remove fuel tank cap nor fill fuel tank while engine is hot or running.
Allow engine to cool at least 2 minutes before refueling.
- Do not overfill the fuel tank.
- If fuel is spilt, wipe it away carefully and wait until the fuel has dried before starting the engine.
- After refueling, make sure that the fuel cap is secured to prevent spillage.

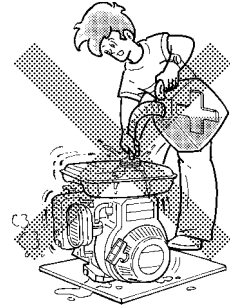

⚠ WARNING : FIRE PREVENTION

- Do not operate the pump while smoking or near an open flame.
- Do not use around dry brush, twigs, cloth rags, or other flammable materials.
- Keep cooling air intake (recoil starter area) and muffler side of the engine at least 1 meter (3 feet) away from buildings, obstructions and other burnable objects.
- Keep the pump away from flammables and other hazardous materials (trash, rags, lubricants, explosives).



⚠ WARNING : OTHER SAFETY PRECAUTIONS

- Be careful of hot parts.
The muffler and other engine parts become very hot while the pump is running or just after it has stopped. Operate the pump in a safe area and keep children away from the running pump.

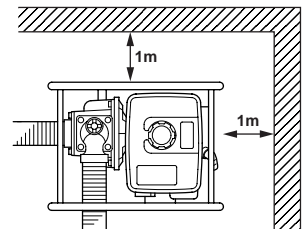

- Do not touch the spark plug and ignition cable when starting and operating the engine.
- Operate the pump on a stable, level surface.
If the engine is tilted, fuel spillage may result.

NOTE

Operating the pump at a steep incline may cause seizure due to improper lubrication even with a maximum oil level.

- Do not transport the pump with fuel in tank or with fuel strainer cock open.
- Keep the unit dry (do not operate it in rainy conditions).

⚠ CAUTION : PRE-OPERATION CHECKS

- Carefully check fuel hoses and joints for looseness and fuel leakage. Leaked fuel creates a potentially dangerous situation.
- Check bolts and nuts for looseness. A loose bolt or nut may cause serious engine trouble.
- Check the engine oil and refill if necessary.
- Check the fuel level and refill if necessary. Take care not to overfill the tank.
- Keep cylinder fins and recoil starter free of dirt, grass and other debris.
- Wear snug fitting working clothes when operating the engine.
Loose aprons, towels, belt, etc., may be caught in the engine or drive train, causing a dangerous situation.

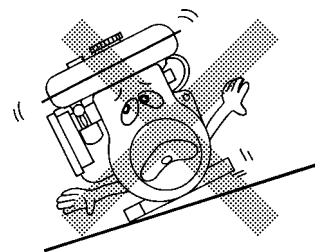

GB

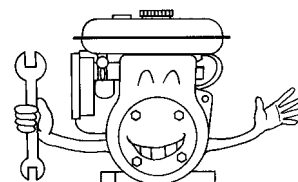

SYMBOLS

	Read the owner's manual.		
	Stay clear of the hot surface.		
	Exhaust gas is poisonous. Do not operate in an unventilated area.		
	Stop the engine before refueling.		
	Fire, open flame and smoking prohibited.		
	On (Run)		Plus ; Positive polarity
	Off (Stop)		Battery
	Engine oil		Engine start (Electric start)
	Add oil		

2. COMPONENTS

(See Fig. 1)

NOTE Please refer to the illustrations on the back page of the front cover or back cover for Fig. 1 to 8 indicated in the sentence.

- | | | |
|-----------------------|-------------------------------|---|
| ① Plug (drain) | ⑨ Choke lever | ⑰ Recoil starter handle |
| ② Suction | ⑩ Muffler | ⑱ Fuel tank |
| ③ Delivery | ⑪ Air cleaner | ⑲ Strainer |
| ④ Frame | ⑫ Drain plug (at two places) | ⑳ Hose coupling |
| ⑤ Plug (priming) | ⑬ Oil filler (with oil guage) | ㉑ Hose band |
| ⑥ Spark plug | ⑭ Casing cover | ㉒ Tools |
| ⑦ Fuel cock | ⑮ Stop switch | ㉓ Cushion rubber |
| ⑧ Speed control lever | ⑯ Recoil starter | ㉔ Bolt, Nut and Washer |
| | | ㉕ Instruction for use
(This publication) |

3. PRE-OPERATION FOR STARTING

(See Fig. ②)

1. CONNECT SUCTION HOSE

(See Fig. ②-①)

Use a reinforced-wall or wire braided hose to prevent suction collapse.

Since the pump self-priming time is directly proportional to hose length, a short hose is recommended.

⚠ CAUTION

Always use a strainer with the suction hose. Gravel or debris sucked into the pump will cause serious damage to the impeller and the pump casting.

2. CONNECT DELIVERY HOSE

(See Fig. ②-②)

When using a fabric hose, always use a hose band to prevent the hose from disconnecting under high pressure.

3. CHECK ENGINE OIL (See Fig. ②-④)

Before checking or refilling engine oil, be sure the engine is located on stable, level surface and stopped.

- Do not screw the oil gauge into the oil filler neck to check oil level. If the oil level is low, refill to the upper level with the following recommended oil.
- Use 4-stroke automotive detergent oil of API service class SE or higher grade.
- Select the viscosity based on the air temperature at the time of operation as shown in the table. (See Fig.②-③)

OIL CAPACITY : 0.6 liter

Explanation of Fig.②-④

- ① Oil Gauge
- ② Upper Level (0.6 liter)
- ③ Lower Level

4. CHECK FUEL (See Fig. ②-⑤)

⚠ WARNING

Do not refuel while smoking, near an open flame or other such potential fire hazards. Otherwise fire accident may occur.

- Stop the engine and open the cap.
- Use unleaded automotive gasoline only.
Fuel Tank Capacity
Refer to "9. SPECIFICATIONS" Page 9 for fuel tank capacity
- Close the fuel cock before filling the fuel tank.

- Do not fill above the top of the fuel filter screen (marked ②), or the fuel may overflow when it heats up later and expands.
- When filling the fuel tank, always use the fuel filter screen.
- Wipe off any spilled fuel before starting the engine.
(See Fig.②-⑥)

5. CHECK PRIMING WATER

(See Fig. ②-⑦)

It is recommended that the water chamber of pump casing should be primed with full of water before operating.

⚠ WARNING

Never attempt to operate the pump without priming water or the pump will overheat. Extended dry operation will destroy the mechanical seal.

If the unit has been operated dry, stop the engine immediately and allow the pump to cool before adding priming water.

GB

4. OPERATING YOUR PUMP

(See Fig. ③)

1. STARTING

- (1) Open the fuel cock. (See Fig.③-①)
- (2) Turn the STOP SWITCH to the position " I " (ON).
(See Fig.③-②)
- (3) Set the speed control lever 1/3 to 1/2 of the way towards the high speed position. (See Fig.③-③)
- (4) Close the choke lever. (See Fig.③-④)
 - If the engine is cold or the ambient temperature is low, close the choke lever fully.
 - If the engine is warm or the ambient temperature is high, open the choke lever half-way, or keep it fully open.
- (5) Pull the starter handle slowly until resistance is felt. This is the "compression" point. Return the handle to its original position and pull swiftly. Do not pull out the rope all the way. After starting the engine, allow the starter handle to return to its original position while still holding the handle. (See Fig.③-⑤)
- (6) After starting the engine, gradually open choke by turning the choke lever and finally keep it fully opened. Do not fully open the choke lever immediately when the engine is cold or the ambient temperature is low, because the engine may stop. (See Fig.④-①)

2. RUNNING

- (1) After the engine starts, set the speed control lever at the low speed position (L) and warm it up without load for a few minutes. (See Fig.⑤-①)

5. MAINTENANCE

(See Fig. 6)

1. DAILY INSPECTION

Before running the engine, check the following service items.

- ① Loose or broken bolts and nuts
- ② Clean air cleaner element
- ③ Enough clean engine oil
- ④ Leakage of gasoline and engine oil
- ⑤ Enough gasoline
- ⑥ Safe surroundings
- ⑦ Check the priming water
- ⑧ Excessive vibration, noise

2. PERIODIC INSPECTION

Periodic maintenance is vital to the safe and efficient operation of your pump.

Check the table below for periodic maintenance intervals. The below chart is based on the normal pump operation schedule.

⚠ CAUTION
Replace rubber pipes for fuel passage every two years. If fuel leakage is found, replace the pipe immediately.

- (2) Gradually move the speed control lever toward the high speed position (H) and set it at the required engine speed. (See Fig. 5-2)

- Whenever high speed operation is not required, slow the engine down (idle) by moving the speed control lever to save fuel and extend engine life.

3. STOPPING

- (1) Set the speed control lever at the low speed position and allow the engine to run at low speed for 2 or 3 minutes before stopping. (See Fig. 5-1)
- (2) Turn the STOP SWITCH counterclockwise to the position "○" (OFF). (See Fig. 5-3)
 - Do not stop the engine suddenly when it is running at high speed.
- (3) Close the fuel cock. (See Fig. 5-4)
- (4) Pull the starter handle slowly and return the handle to its original position when resistance is felt. This operation is necessary to prevent outside moist air from intruding into the combustion chamber. (See Fig. 5-5)

✳ STOPPING ENGINE WITH THE FUEL COCK

Close the fuel cock and wait for a while until the engine stops. Avoid to let the fuel remain in the carburetor over long periods, or the passages of the carburetor may become clogged with impurities, and malfunctions may result.

Maintenance items	Every 8 hours (Daily)	Every 50 hours (Weekly)	Every 200 hours (Monthly)	Every 300 hours	Every 500 hours	Every 1000 hours
CLEAN PUMP SET AND CHECK BOLTS AND NUTS	● (Daily)					
CHECK AND REFILL ENGINE OIL	● (Refill daily up to upper level.)					
CHANGE ENGINE OIL	(Initial 20 hours)	●				
CLEAN SPARK PLUG		●				
CLEAN AIR CLEANER		●				
REMOVE THE PUMP CASING AND CLEAN			●			
CLEAN FUEL STRAINER			●			
CLEAN AND ADJUST SPARK PLUG AND ELECTRODES			●			
CHECK AND ADJUST VALVE CLEARANCE				●		
REMOVE CARBON FROM CYLINDER HEAD					●	
CLEAN AND ADJUST CARBURETOR					●	
OVERHAUL ENGINE IF NECESSARY						●

3. INSPECTING THE SPARK PLUG (See Fig. 7-①)

- (1) Clean off carbon deposits on the spark plug electrode using a plug cleaner or wire brush.
- (2) Check electrode gap. The gap should be 0.6 mm to 0.7 mm (0.02 inch.–0.03 inch.). Adjust the gap, if necessary, by carefully bending the side electrode.

Recommended Spark Plug
NGK-B6HS or BR6HS (CHAMPION-L86C or RL86C)

4. ENGINE OIL CHANGE (See Fig. 7-②,③)

Initial oil change : After 20 hours of operation
Thereafter : Every 50 hours of operation

- (1) When changing oil, stop the engine and loosen the drain plug. Drain the used oil while the engine is warm. Warm oil drains quickly and completely.

⚠ CAUTION

Make sure the fuel cap is tightly secured to avoid spillage.

- When changing oil, stop the engine and loosen the drain plug.
- Tighten the drain plug before refilling.
- Refer to the recommended oil table on page 6.
- Always use the proper grade and clean oil. If the engine oil is contaminated, there is not enough or it is of poor quality, engine life will be shortened.

5. CLEANING FUEL STRAINER (See Fig. 7-⑤)

⚠ WARNING Flame Prohibited

- (1) Inspect fuel strainer for water and dirt.
(See Fig. 7-⑤-①)
- (2) To remove water and dirt, close the fuel cock and remove the strainer cup.
- (3) After removing dirt and water, wash the strainer cup with gasoline. Reinstall securely to prevent leakage.

6. CLEANING AIR CLEANER (See Fig. 7-④)

⚠ WARNING Flame Prohibited

A dirty air cleaner element will cause starting difficulty, power loss, engine malfunctions, and shorten engine life extremely. Always keep the air cleaner element clean.

- Urethane Foam Element Type (See Fig. 7-④)

Remove the element (7-④-②) and wash it in kerosene or diesel fuel. Then saturate it in a mixture of 3 parts kerosene or diesel fuel and 1 part engine oil. Squeeze the element to remove the mixture and install it in the air cleaner.

Clean and replace air cleaner elements more often when operating in dusty environments.

7. FUEL HOSE REPLACEMENT (See Fig. 7-⑥)

⚠ WARNING

Take extreme caution when replacing fuel hose ; gasoline is extremely flammable.

Replace the fuel hose every 2 years. If fuel leaks from fuel hose, replace the fuel hose immediately.

8. CHECKING BOLTS, NUTS AND SCREWS

- Retighten loose bolts and nuts.
- Check for fuel and oil leaks.
- Replace damaged parts with new ones.

9. CLEANING PUMP INSIDE

- Turn the knob counterclockwise and open the casing cover holder.
- Pull the casing toward you, and then remove the casing and the inner casing.
- Clean the inside of pump casing and casing cover with clean water.

6. PREPARATIONS FOR STORAGE

1. WATER (See Fig. 8-1)

Drain all water from the drain plug.

CAUTION

When retightening drain plug, be sure to clean the drain plug and the thread of casing. Otherwise, the thread may be damaged.

2. DISCHARGE FUEL (See Fig. 8-4)

WARNING Flame Prohibited

GB If you do not use the engine more than 1 month, discharge fuel to prevent gum in the fuel system and carburetor parts.

- Remove the strainer cup, place the strainer over a container and open the strainer cock to discharge fuel from the fuel tank.
- Remove the drain screw of the carburetor float chamber and discharge fuel.

3. ENGINE OIL (See Fig. 8-5)

- Change the engine oil with fresh oil.
- Remove the spark plug, pour about 5 cc of engine oil into the cylinder, slowly pull the starter handle of the recoil starter 2 or 3 times, and reinstall the spark plug.

4. CLEAN AND STORE

- Slowly pull the recoil starter handle until resistance is felt and leave it in that position.
- Clean the pump thoroughly with an oiled cloth, put the cover on, and store the pump indoors in a well ventilated, low humidity area.

7. OIL SENSOR INSTRUCTIONS

(OPTIONAL)

1. FUNCTION OF OIL SENSOR

The engine will stop automatically when the oil level falls below the safety limit. The engine cannot be started unless the level is raised above the prescribed limit.

(See Fig. 8-2)

2. RESTARTING

- (1) Fill the crankcase with oil up to the proper level.
- (2) As for restarting and operating the engine, refer to section "4. OPERATING YOUR PUMP" on page 5.
 - Check the wire connector from the engine. It must be connected securely to the wire from oil sensor. (See Fig. 8-3-2) Fix the earth wire.)
 - Do not remove the oil sensor from the engine for checking oil level and refilling. (See Fig. 8-3-1)
 - When selecting the engine oil, refer to page 5 for the recommended oil.

8. EASY TROUBLESHOOTING

1. PUMP DOES NOT RUN .

- Engine dose not start. (See 8.-4 "4. WHEN ENGINE DOES NOT START")
- Sticking of impeller (Disassemble and clean.)

2. PUMPING VOLUME IS SMALL.

- Sucking air at suction side. (Check piping at suction side.)
- Drop off engine output (Consult your nearest dealer.)
- Breakage of mechanical seal. (Consult your nearest dealer.)
- High suction lift (Lower.)
- Suction hose is too long or thin. (Use a thick hose in minimum length.)
- Leak of water from water passage. (Stop leaking.)
- Clogging of foreign substance in impeller. (Disassemble and clean.)
- Wear of impeller.
- Strainer is clogged. (Clean.)
- Engine speed is too low. (Consult your nearest dealer.)

3. PUMP DOES NOT SELFPRIME.

- Suction of air at suction side. (Check piping at suction side.)
- Insufficient priming water inside pump casing (Prime fully.)
- Imperfect tightening of drain plug. (Tighten the plugs completely.)
- Engine speed is too low. (Consult your nearest dealer.)
- Sucking air from mechanical seal. (Consult your nearest dealer.)

4. WHEN ENGINE DOES NOT START :

Perform the following checks before you take the pump to your Robin dealer. If you still have trouble after completing the checks, take the pump to your nearest Robin dealer.

⚠ WARNING

Before testing, carefully wipe off spilled fuel.

Put the plug as far away from the spark plug hole as possible.

Ground the side of the electrode to any engine ground.

(1) Is there a strong spark across the electrode ?

- Remove the spark plug and connect it to the plug cap. Pull the starter handle while grounding spark plug against engine body.
- Try with a new spark plug if the spark is weak or there is no spark.
- The ignition system is faulty if there is no spark with a new spark plug.

(2) Is there enough compression?

- Pull the starter handle slowly and check if resistance is felt.
- If little force is required to pull the starter handle, check if the spark plug is tightened firmly.
- If the spark plug is loose, tighten it.

(3) Is the spark plug wet with fuel?

- Is the fuel cock opened?
- Choke (close choke lever) and pull the starter handle five or six times. Remove the plug and check if its electrode is wet. If the electrode is wet, fuel is well supplied to your engine.
- When the electrode is dry, check where the fuel stops. (Check the fuel intake of the carburetor and fuel strainer intake.)
- In case the engine does not start with well supplied fuel, try using fresh fuel.

GB

9. SPECIFICATIONS

Model		PKG205	PKG305
PUMP	Type	Self-priming, Centrifugal pump	
	Suction×Delivery Diameters	50×50 mm (2×2in.)	80×80 mm (3×3in.)
	Total Head	29m	26m
	Maximum Delivery Volume	590 ℓ /min	960 ℓ /min
	Suction Head	8m	
	Axle Seal Material(Mechanical Seal)	Ceramic-carbon	
ENGINE	Model	EY15-3D	EY20-3D
	Type	Robin Air-cooled, 4-stroke, Gasoline engine	
	Lubricant	Automotive detergent oil (API/SE or higher grade, SAE/10W-30 etc.)	
	Oil Capacity	0.6L	
	Fuel	Automobile gasoline	
	Fuel Tank Capacity	2.8L	3.8L
	Spark Plug	NGK-B6HS or BR6HS (CHAMPION-L86C or RL86C)	
	Starting System	Recoil starter	
Dimensions (L×W×H)	464×315×428mm	510×355×480mm	
Net Weight	22.5kg	27.0kg	
Standard Accessories	Engine tool kit (1 set), Strainer (1 pc.), Hose coupling (2 pcs.), Hose band (3 pcs.), Cushion rubber (4 pcs.).		