

INSTRUCTIONS FOR USE
GENERATORS

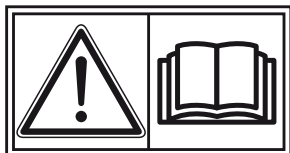

MODELS
SILENTSTAR
6000D M YN
6500D T YN



Thank you for purchasing a Worms Entreprises generator.

This manual covers operation and maintenance of the Worms Entreprises generators. All information in this publication is based on the latest production information available at the time of approval for printing.

Pay special attention to statements preceded by the following words:



Indicates an impending dangerous situation. If this one is not prevented, it can cause death or severe injuries for the user..

WARNING

Indicates a strong possibility of severe personal injury, loss of life and equipment damage if instructions are not followed.

CAUTION

Indicates a possibility of personal injury or equipment damage if instructions are not followed.

NOTE

Gives helpful information.

If a problem should arise, or if you have any questions about the generator, consult an authorized dealer or service shop.

WARNING

The generator is designed to give safe and dependable service if operated according to instructions.







Do not operate the generator before you have read and understood the instructions. Failure to do so could result in death, personal injury or equipment damage.



















SUMMARY

1. SYMBOLS AND MEANINGS	PAGE 4
2. SAFETY PRECAUTIONS	PAGE 6
3. SPECIFICATIONS	PAGE 8
4. CONTROL PANEL	PAGE 9
5. PRE-OPERATION CHECK	PAGE 10
6. OPERATING PROCEDURES	PAGE 13
7. STOPPING THE GENERATOR	PAGE 15
8. OIL SENSOR	PAGE 16
9. WATTAGE INFORMATION	PAGE 16
10. MAINTENANCE SCHEDULE	PAGE 17
11. “HOW TO” MAINTENANCE	PAGE 18
12. PREPARATION FOR STORAGE	PAGE 20
13. TROUBLESHOOTING	PAGE 21

1. SYMBOLS AND MEANINGS

In accordance with the ISO standard, the specified symbols as shown in the following table are used for the products and this instruction manual.

	Read the operator's instruction manual.
	Stay clear of the hot surface.
	Exhaust gas is poisonous. Do not operate in an unventilated room.
	Stop the engine before refueling.
	Fire, naked flame and smoking prohibited.
	Caution, risk of electric shock.
	Do not connect the generator to the commercial power lines.

	ON (Switch Engine)	P_r	Rated power (kW)
	OFF (Switch Engine)	f_r	Rated frequency (Hz)
	Alternating current	H_{max}	Maximum site altitude above sea-level (m)
	Direct current	COP	Continuous power (kW)
	Plus : positive polarity	U_r	Rated voltage (V)
	Minus : negative polarity	T_{max}	Maximum ambient temperature (°C)
	STOP-position of a bistable push control	$\cos \varphi$	Rated power factor
	ON-position of a bistable push control	I_r	Rated current (A)
	Protective earth (ground)	m	Mass (kg)
	Fuse		
	Engine oil		
	Add oil		
	Battery charging condition		
	Choke (cold starting aid)		
	Engine start (Electric start)		
	Engine stop (Electric start)		
	Fuel		
	Fast		
	Slow		

2. SAFETY PRECAUTIONS

-  Do not operate the generator near gasoline or gaseous fuel because of the potential danger of explosion or fire.



-  Do not fill the fuel tank with fuel while the engine is running. Do not smoke or use a naked flame near the fuel tank. Be careful not to spill fuel during refueling. If fuel is spilt, wipe it off and let dry before starting the engine.





-  Do not place inflammable near the generator. Be careful not to place fuel, matches, gunpowder, oily cloths, straw, trash, or any other in flammables near the generator.

-  Do not operate the generator inside a room, cave, tunnel, or other insufficiently ventilated area. Always operate it in a well-ventilated area, otherwise the engine may become overheated, and the poisonous carbon monoxide gas contained in the exhaust gases will endanger human lives. Keep the generator at least 1 meter (3 feet) away from any structure or building during use. If the generator must be used indoors, the area must be well-ventilated and extreme caution must be taken regarding the discharge of exhaust gases. Failure to follow the correct procedures can be fatal.





-  Do not enclose the generator nor cover it with a box. The generator has a built-in forced air cooling system, and may become overheated if it is enclosed. If generator has been covered to protect it from the weather during non use, be sure to remove it and keep it well away from the area during generator use.

-  Operate the generator on a level surface. It is not necessary to prepare a special foundation for the generator. However, the generator will vibrate on an irregular surface, so choose a level place without surface irregularities. If the generator is tilted or moved during operation, fuel may spill and/ or the generator may tip over, causing a hazardous situation. Proper lubrication cannot be expected if the generator is operated on a steep incline or slope. In such a case, piston seizure may occur even if the oil level is above the minimum level.

-  Pay attention to the wiring or extension cords from the generator to the connected device. If the wire is under the generator or in contact with a vibrating part, it may break and possibly cause a fire, generator burnout, or electric shock hazard. Replace damaged or worn cords immediately.



-  Do not operate in rain, in wet or damp conditions, or with wet hands. The operator may suffer severe electric shock if the generator is wet due to rain or snow.

-  If the generator is wet, wipe and dry it before starting. Do not pour water directly over the generator, never wash it with water.



 Be extremely careful that all necessary electrical grounding procedures are followed during each and every use. Failure to do so can be fatal.

 Do not contact the generator to a commercial power line. Connection to a commercial power line may short circuit the generator and ruin it or cause electric shock hazard. Use the transfer switch for connecting to domestic circuit. In the special case where the generator will be connected as stand by to the commercial network, the installation must be carried out by a qualified electrician taking into account the technical specifications of the generator and the commercial network.





 No smoking while handling the battery. The battery emits flammable hydrogen gas, which can explode if exposed to electric arcing or a naked flame. Keep the area well-ventilated and keep naked flames/sparks away when handling the battery.



 Engine becomes extremely hot during and for some time after operation. Keep combustible materials well away from generator area. Be very careful not to touch any parts of the hot engine especially the muffler area or serious burns may result.



 Keep children and all bystanders at a safe distance from work areas.

 It is absolutely essential that you know the safe and proper use of the power tool or appliance that you intend to use. All operators must read, understand and follow the tool/appliance owners manual. Tool and appliance applications and limitations must be understood. Follow all directions given on labels and warnings. Keep all instruction manuals and literature in a safe place for future reference.



 Use only «Homologated» extension cords according to CEI 245-4. When a tool or appliance is used outdoors, use only extension cords marked «For Outdoor Use». Extension cords, when not in use should be stored in a dry and well ventilated area.

 Always switch off generator's circuit breaker and disconnect tools or appliances when not in use, before servicing, adjusting, or installing accessories and attachments.

3. SPECIFICATIONS

		SILENTSTAR 6000D M YN	SILENTSTAR 6500D T YN
LTP Power 230V ($\cos\varphi=1$)		5200 W	3600 W
COP Power 230V ($\cos\varphi=1$)		4400 W	3600 W
LTP Power 400V ($\cos\varphi=0,8$)		-	5200 W / 6500 VA
COP Power 400 V ($\cos\varphi=0,8$)		-	4400 W / 5500 VA
Noise Power Level (Lwa)		97 dB	
ALTERNATOR	Nominal Voltage	230 V single phase	400 V three phases
	Type	Brushless, 2 poles	
	Voltage Regulation	Condenser	
	Frequency	50 Hz	
	Single socket 230 V - 10/16 A SCHUKO	1	1
	Single socket 230V IP44 - 16 A	1	1
	Single socket 230V - 32A (CEE)	1	-
	Three socket 400V - 3P+T+N 16A	-	1
	Voltmeter	Serial	
	Frequencymeter	Serial	
Hourmeter	Serial		
ENGINE	Engine Model	L100AE - YANMAR	
	Engine Type	4 stroke DIESEL	
	Cooling System	Air cooled	
	Maximum Output	8,8 HP - 3000 rpm	
	Piston Displacement	435 cm ³	
	Fuel	Diesel	
	Fuel Tank Capacity	22 L	
	Autonomy at 3/4 Load	14 h 20	
	Starting System	Electric	
Electronic Oil Sensor	Serial		
Frame	Sound proof canopy - Double layer panels		
Dimensions LxH (mm)	860 x 560 x 720 mm		
Packaging Dimensions LxH (mm)	1130 x 630 x 930 mm		
Dry Weight	175 kg	180 kg	
Gross Weight	190 kg	195 kg	

4. CONTROL PANEL

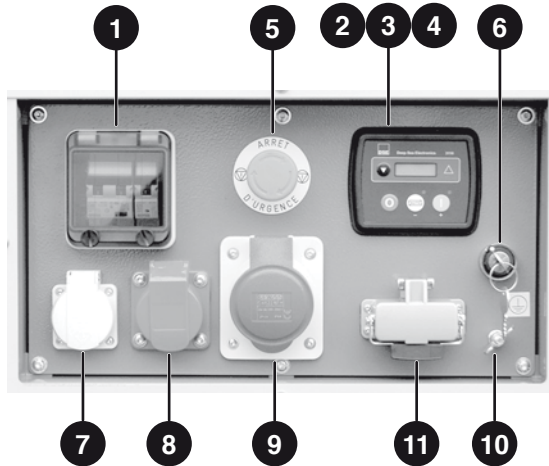

- 1** Current leakage protection and circuit breaker
- 2** Voltmeter
- 3** Hourmeter
- 4** Frequency meter
- 5** Emergency Stop
- 6** Key Switch
- 7** Single phase socket 230 V - 10/16 A SCHUKO
- 8** Single phase socket 230 V - 16 A CEE
- 9** Single phase socket 230 V - 32 A - CEE or Three phase socket 400 V - 3P+T+N 16 A
- 10** Earth connection
- 11** Connection for additional options

5. PRE-OPERATION CHECK

CHECK ENGINE OIL

Before checking or refilling oil, be sure generator is located on stable and level surface with engine stopped.

- Remove oil filler cap (a) and check the engine oil level.

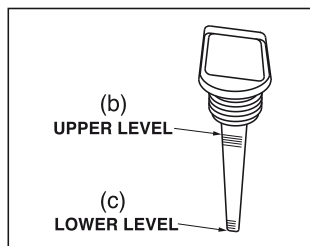
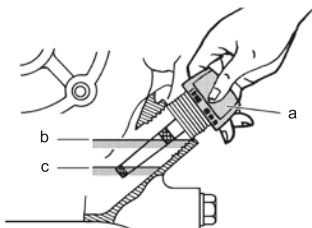

- If oil level is below the lower level line (c), refill with suitable oil (see table) to upper level line (b). Do not screw in the oil filler cap when checking oil level.

Oil Capacity	Upper Level
SILENTSTAR 6000D MYN	1,6 L
SILENTSTAR 6000D TYN	1,6 L

- Change oil if contaminated. (See «How-To» Maintenance.)

RECOMMENDED ENGINE OIL:

Use class SE (API classification) oil or a higher grade oil according to the table below. **SAE 10W-30** is recommended for general, all temperature use. If single viscosity oil is used, select the appropriate viscosity for the average temperature in your area.

WARNING

Do not remove the fuel tank cap while the engine is running. Do not refuel while smoking or near naked flame or other such potential fire hazards. Otherwise fire accident may occur.

CHECK ENGINE FUEL

WARNING

Do not remove the fuel tank cap while the engine is running. Do not refuel while smoking or near naked flame or other such potential fire hazards. Otherwise fire accident may occur.

Check fuel level at fuel level gauge (standard with large fuel tanks). If fuel level is low, refill with Diesel. Be sure to use the fuel filter screen on the fuel filter neck before filling the tank. Make sure the fuel filter is filled. If not enough inside the filter, it is necessary to drain the air.

Fuel tank capacity : see page 8.

PROCEDURE TO DRAIN AIR FROM THE HOSES

WARNING

After a first starting process or after a engine failure due to a lack of Diesel, it is necessary to drain air from the fuel hoses between the tank and the injection pump before starting the generator.

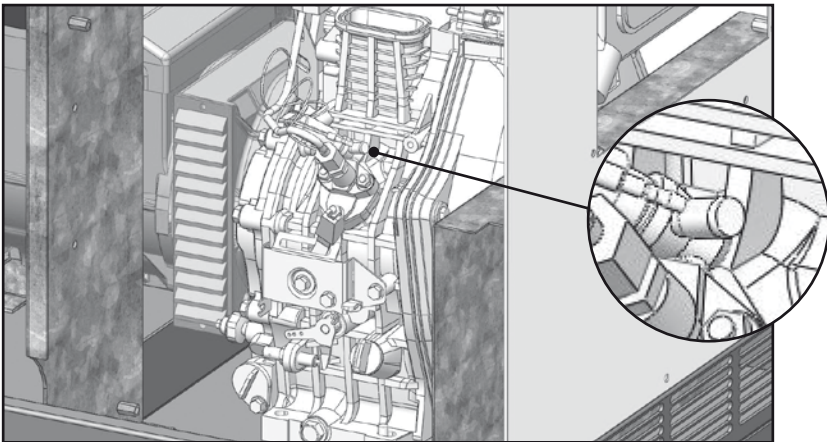

If the fuel filter or the fuel hoses get air, it is necessary to disconnect the Diesel hose close to the injection pump and drain it.

WARNING

- Make sure you review each warning in order to prevent fire hazard.
- Do not refill tank while engine is running or hot.
- Be careful not to admit dust, dirt, water or other foreign objects into fuel.
- Wipe off split fuel thoroughly before starting engine.
- Keep naked flames away.

CHECKING COMPONENT PARTS

Check following items before starting engine:

- Fuel leakage from fuel hose, etc;
- Bolts and nuts for looseness;
- Components for damage or breakage;
- Generator not resting on or against any adjacent wiring.
- Control generator environment

WARNING

- Make sure you review each warning in order to prevent fire hazard.
- Keep area clear of in flammables or other hazardous materials.
- Keep generator at least 3 feet (1 meter) away from buildings or other structures.
- Only operate generator in a dry, well ventilated area.
- Keep exhaust pipe clear of foreign objects.
- Keep generator away from naked flame. No smoking!
- Keep generator on a stable and level surface.
- Do not block generator air vents with paper or other material.

GROUNDING THE GENERATOR

- Before using the generator, the grounding lug on the panel must be connected to the earth.
- To ground the generator to the earth, connect the grounding lug of the generator to the grounding spike driven into the earth or to the conductor which has been already grounded to the earth.
- If such grounding conductor or grounding electrode is unavailable, connect the grounding lug of the generator to the grounding terminal of the using electric tool or appliance.

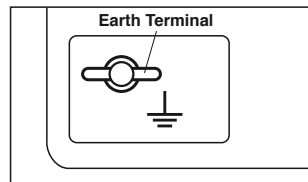

6. OPERATING PROCEDURES

⚠ WARNING

Check the oil level before each operations as outlined on page 9. Never change the accelerator position which is set at the factory.

⚠ WARNING

Before starting the generator, check the DIESEL hoses are air drained.

6.1. STARTING THE ENGINE

NOTE

All the information related to the display is written in the manual user book.

- Turn the key in "ON" position. During this time, the display turns on (see below the description of the display).
- Press "START" button  to start the engine and let it run for few minutes with no load.



FONCTION	DESCRIPTION
1 START button	<ul style="list-style-type: none">● In manual mode : press to start the generator
2 AUTO button	<ul style="list-style-type: none">● Press to change to automatic mode
3 OFF / RESET button	<ul style="list-style-type: none">● Press to stop the generator when it is running● Press to reset the alarms after a failure.● Press 3 sec. to test the LED of the control panel

4

Scroll / Go down button

- Press to scroll the menu
- Press to decrease the value during a setup.

**WARNING**

In case of use with automatic transfer switch (ATS) or remote set, the key switch must be in “OFF” position.

6.2. DIFFERENT INFORMATION FROM THE GENERATOR DISPLAY

- It is possible to scroll down different information thanks to the button able to scroll the pages:
- Once chosen, the page will remain the display information until the user chooses another page.
- If an alarm is enabled, the display shows the problem with a symbol paying attention of the user.

Hereunder several options are visible on the display during the working time:

3000 RPM	Speed of the engine
↓	
230 V	Voltage of the generator
↓	
50 Hz	Frequency of the generator
↓	
16.2 h	Working Time of the engine
↓	
13.8 V	Battery Voltage

6.3. USING ELECTRIC POWER**AC APPLICATION**

This generator is thoroughly tested and adjusted in the factory. If the generator does not produce the specified voltage, consult your nearest Worms dealer or service shop.

- Turn off the switch(es) of the electrical appliance(s) before connecting to the generator.
- Insert the plug(s) of the electrical appliance(s) into the receptacle.

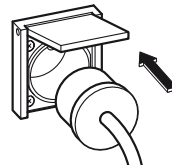
**WARNING**

Be sure to ground the generator if the connected electrical device is grounded.
Failure to ground unit could lead to electrical shock.

- Check the amperage of the receptacles, and be sure not to take a current exceeding the specified amperage.
- Be sure that the total wattage of all appliances does not exceed the rated output of the generator.

⚠ WARNING

Do not put foreign objects into the plug receptacle.

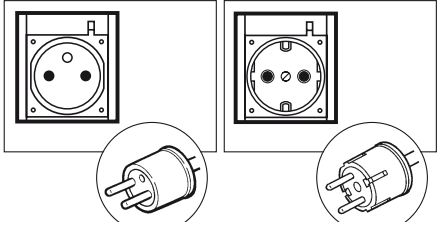

NOTE

When the circuit breaker or no-fuse breaker turns off during operation, the generator is overloaded or the appliance is defective. Stop the generator immediately, check the appliance and/or generator for overloading or detect and have repaired as necessary by Worms dealer or service shop.

7. STOPPING THE GENERATOR

1. Turn off the power switch of the electric equipment and unplug the cord from the receptacle of the generator.
2. Allow the engine about 3 minutes to cool down at no-load before stopping.
3. Press the OFF / RESET button  to stop the generator.
4. Turn the key switch to "OFF" position.



⚠ WARNING

The generator must always be stored with the key in "OFF" position. If not, the battery will be discharged after a long storage time.

8. OIL SENSOR

- (a) The oil sensor detects the fall in oil pressure in the crankcase and automatically stops the engine when the oil pressure falls below a predetermined level.
- (b) When engine has stopped automatically, switch off the generator, and check the oil level. Refill engine oil to the upper level as instructed on page 10 and restart the engine.

NOTE

If the engine doesn't start by usual, consult your nearest Worms Entreprises dealer or service shop.

9. WATTAGE INFORMATION

Some appliances need a "surge" of energy when starting. This means that the amount of electrical power needed to start the appliance may exceed the amount needed to maintain its use. Electrical appliances and tools normally come with a label indicating voltage, cycles/Hz, amperage (amps) and electrical power needed to run the appliance or tool. Check with your nearest dealer or service center with questions regarding power surge of certain appliances or power tools.

- Electrical loads such as incandescent lamps and hot plates require the same wattage to start as is needed to maintain use.
- Loads such as fluorescent lamps require 1.2 to 2 times the indicated wattage during start-up.
- Loads for mercury lamps require 2 to 3 times the indicated wattage during start-up.
- Electrical motors require a large starting current. Power requirements depend on the type of motor and its use. Once enough "surge" is attained to start the motor, the appliance will require only 30% to 50% of the wattage to continue running.
- Most electrical tools require 1.2 to 3 times their wattage for running under load during use. For example, a 5,000 watt generator can power a 1800 to 4000 watt electrical tool.
- Loads such as submersible pumps and air compressors require a very large force to start. They need 3 to 5 times the normal running wattage in order to start. For example, a 5,000 watt generator would only be able to drive a 1,000 to 1,700 watt pump.

NOTE

The following wattage chart is general guide only. Refer to your specific appliance for correct wattage. To determine the total wattage required to run a particular electrical appliance or tool, multiply the voltage figure of the appliance/tool by the amperage (amps) figure of the same appliance / tool. The voltage and amperage (amps) information can be found on a name plate which is normally attached to electrical appliances and tools.

	SILENTSTAR 6000D M YN	SILENTSTAR 6500D T YN
Bulb / Halogen / Heating	5000 W	5000 W
Neons - Low consumption Bulb	2500 W	2500 W
Hand Tools without variator	4000 W	4000 W
Compressor	1800 W	1800 W
Electric Moteur Without Load	4,5 HP / 3,3 kW	4,5 HP / 3,3 kW
Welder	110 A maxi	110 A maxi

AVR OPTION		
Voltage regulating	± 2 %	± 2 %

VOLTAGE DROP IN ELECTRIC EXTENSION CORDS

When a long electric extension cord is used to connect an appliance or tool to the generator, a certain amount of voltage drop or loss occurs in the extension cord which reduces the effective voltage available for the appliance or tool.

The chart below has been prepared to illustrate the approximate voltage loss when an extension cord of 300 feet (approx. 100 meters) is used to connect an appliance or tool to the generator.

Nominal Cross mm ²	No. A.W.G. N°	Allowable Current A	Nb./ Ø N°/mm	Resistance /100m	(A)							Voltage drop
					1 A	3 A	5 A	8 A	10 A	12 A	15 A	
0,75	18	7	30/0.18	2,477	2,5V	8V	12V	-	-	-	-	
1,27	16	12	30/0.18	1,486	1,5V	5V	7,5V	12V	15V	18V	-	
2,0	14	17	37/0.26	0,952	1V	3V	5V	8V	10V	12V	15V	
3,5	12 à 10	23	45/0.32	0,517	-	1,5V	2,5V	4V	5V	6,5V	7,5V	
3,5	10 à 8	35	70/0.32	0,332	-	1V	2V	2,5V	3,5V	4V	5V	

10. MAINTENANCE SCHEDULE

Daily (8 h)	<ul style="list-style-type: none"> ● Check all components according to "PRE-OPERATING CHECKS". ● Check and refill Diesel and engine oil.
Every 50 h	<ul style="list-style-type: none"> ● Wash air cleaner foam element more often if used in dirty or dusty environments. ● Check the condition of the paper element. Do not wash the paper element.
Every 200 h	<ul style="list-style-type: none"> ● Replace air cleaner element. ● Clean fuel strainer. ● Clean and adjust spark plug gap. ● Change oil more often if used in dusty or dirty environment
Every 300 h	<ul style="list-style-type: none"> ● Check and adjust valve clearance (0,15 mm).
Every 500 h	<ul style="list-style-type: none"> ● Remove carbon from cylinder head and the top of the cylinder. ● Clean and adjust carburetor. ● Replace engine mount rubber.
Every 1000 h (24 months)	<ul style="list-style-type: none"> ● Inspect control panel parts. ● Check rotor and stator. ● Overhaul engine. ● Change fuel lines.

NOTE

- Maintenance operations require trained and qualified personnel.
- The maintenance schedule is given as a guide. Under severe conditions, the frequency of maintenance must be increased.
- Initial oil change should be performed after first twenty (20) hours of use. Thereafter change oil every 100 hours. Before changing the oil, check for a suitable way to dispose of the old oil. Do not pour it down sewage drains, onto garden soil or into open streams. Your local zoning or environmental regulations will give you more detailed instructions on proper disposal.

11. “HOW-TO” MAINTENANCE

11.1. ENGINE OIL CHANGE

Change engine oil every 200 hours (for new engine, change oil after 50 hours).

- Open the hatch of the generator. Drain oil by removing the drain plug and the oil filter cap while the engine is warm.
- Reinstall the drain plug and fill the engine with oil until it reaches the upper level on the oil filter cap.

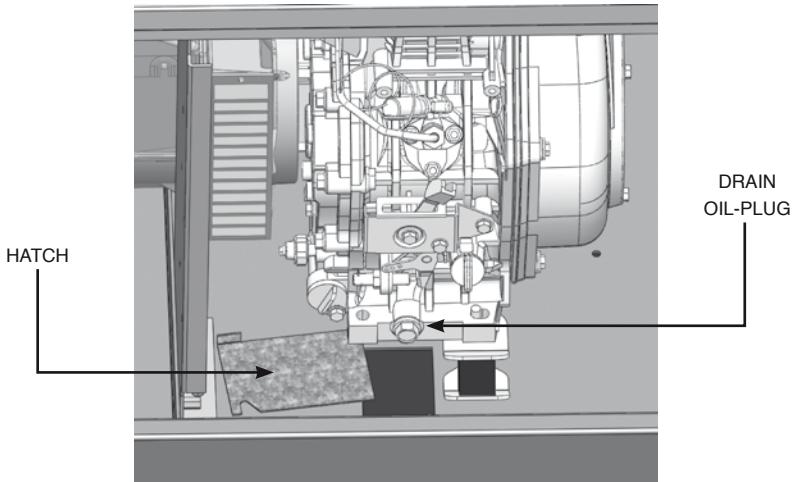

Use new and high quality lubricating oil to the specified level as mentioned in the page 10. If contaminated oil or deteriorated oil is used or the quantity of the engine oil is not sufficient, the engine damage will result and its life will be greatly shortened.

11.2. CLEANING AIR CLEANER

A dirty air cleaner element will cause starting difficulty, power loss, engine malfunctions, and shorten engine life extremely. Always keep the air cleaner element clean.

- **URETHANE FOAM CLEANING:** Work and clean the urethane foam with detergent. After cleaning, dry it. Clean the urethane foam element every 50 hours.
- **PAPER ELEMENT:** Clean by tapping gently to remove dirt and blow off dust. Never use oil. Clean or replace the paper element every 50 hours of operation, and replace element set every 200 hours.

Clean and replace air cleaner elements more often when operating in dusty environments.

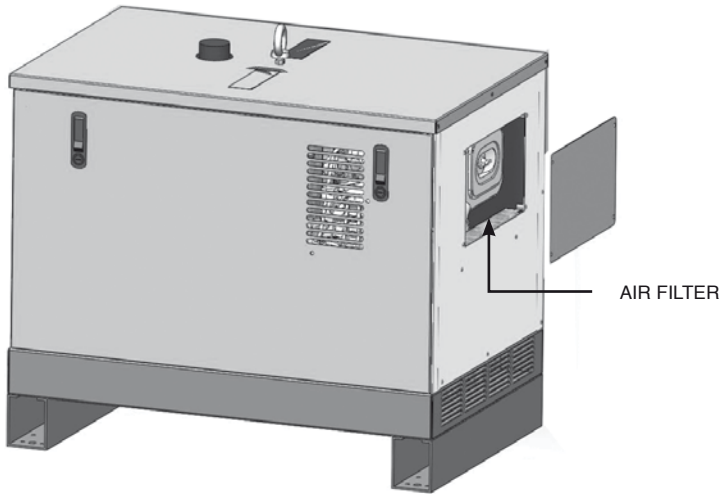

WARNING

URETHANE FOAM CLEANING : Remove the element, wash and clean the urethane foam in kerosene. Saturate in a mixture of 3 parts kerosene and 1 part engine oil, and then squeeze to remove excess oil and put it back to the air filter.

DANGER

Fire forbidden.

11.3. CONTROL OF THE BATTERY VOLTAGE

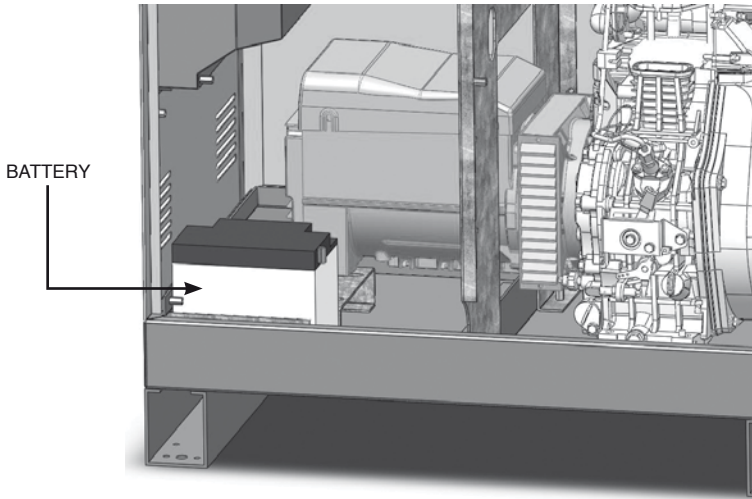

12. PREPARATION FOR STORAGE

The following procedures should be followed prior to storage of your generator for periods of 6 months or longer.

- Drain fuel from fuel tank carefully by disconnecting the fuel line. Diesel left in the fuel tank will eventually deteriorate making engine-starting difficult.
- Close the fuel cock before storage.
- Change engine oil.
- Check for loose bolts and screws, tighten them if necessary.
- Clean generator thoroughly with oiled cloth. Spray with preservative if available.

WARNING

NEVER USE WATER TO CLEAN YOUR GENERATOR.

- Store generator in a well ventilated, low humidity area.

13. TROUBLESHOOTING

When generator engine fails to start after several attempts, or if no electricity is available at the output socket, check the following chart.

If your generator still fails to start or to generate electricity, contact your nearest Worms Entreprises dealer or service shop for further information or corrective procedures.

WHEN ENGINE FAILS TO START:

Check if electrical wires from the fuel solenoid and oil sensor are well connected.	Reconnect the wires if necessary.
Check the voltage of the battery.	Must be over 12V.
Check fuel level.	If empty, refill fuel tank making sure not to overfill.
Check if the key switch of the engine is in the good position.	Turn the key switch to "ON" position.
Check to make sure generator is not connected to an appliance.	If connected, turn off the power switch on the connected appliance and unplug.

WHEN NO ELECTRICITY IS GENERATED AT RECEPTACLE:

Check to make sure no-fuse breaker is in the "I" (ON) position.	After making sure that the total wattage of the electrical appliance is within permissible limits and there are no defects in the appliance, turn the no-fuse breaker to the "I" (ON) position. If breakers continue to actuate, consult your nearest servicing dealer.
Check AC terminals for loose connection.	Secure connection if necessary.
Check to see if engine starting was attempted with appliances already connected to generator.	Turn off switch on the appliance, and disconnect cable from receptacle. Reconnect after generator has been started properly.

MU_02GE_SILENTSTAR_6000D_6500D_EN

WORMS
ENTREPRISES

Siège social / Head Office

ZAC de Lamirault
39 rue de Lamirault, 77090 Collégien, FRANCE
TEL. +33 (0) 1 64 76 29 50
FAX +33 (0) 1 64 76 29 99

Service SAV et Garantie

After Sales and Warranty Service
TEL. +33 (0) 1 64 76 29 80
FAX +33 (0) 1 64 76 29 88