

INSTRUCTIONS FOR USE GENERATORS

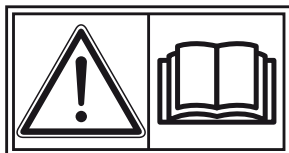

MODELS
SILENTSTAR
7 M AVR YN
7 T AVR YN
11000D M AVR YN
11000D T AVR YN
13000D M AVR YN
13000D T AVR YN



Thank you for purchasing a Worms Entreprises generator.

This manual covers operation and maintenance of the Worms Entreprises generators. All information in this publication is based on the latest production information available at the time of approval for printing.

Pay special attention to statements preceded by the following words:



Indicates an impending dangerous situation. If this one is not prevented, it can cause death or severe injuries for the user..

WARNING

Indicates a strong possibility of severe personal injury, loss of life and equipment damage if instructions are not followed.

CAUTION

Indicates a possibility of personal injury or equipment damage if instructions are not followed.

NOTE

Gives helpful information.

If a problem should arise, or if you have any questions about the generator, consult an authorized dealer or service shop.

WARNING

The generator is designed to give safe and dependable service if operated according to instructions.

























Do not operate the generator before you have read and understood the instructions. Failure to do so could result in death, personal injury or equipment damage.

SUMMARY











1. SYMBOLS AND MEANINGS	PAGE 4
2. SAFETY PRECAUTIONS	PAGE 5
3. SPECIFICATIONS	PAGE 7
4. CONTROL PANEL	PAGE 8
5. PRE-OPERATION CHECK	PAGE 9
6. OPERATING PROCEDURES	PAGE 13
7. STOPPING THE GENERATOR	PAGE 16
8. OIL SENSOR	PAGE 17
9. WATTAGE INFORMATION	PAGE 17
10. MAINTENANCE SCHEDULE	PAGE 19
11. “HOW TO” MAINTENANCE	PAGE 20
12. PREPARATION FOR STORAGE	PAGE 22
13. TROUBLESHOOTING	PAGE 23

1. SYMBOLS AND MEANINGS

In accordance with the ISO standard, the specified symbols as shown in the following table are used for the products and this instruction manual.

	Read the user's manual.		Shut off fuel valve when the engine is not in use.
	Stay clear of any hot surface.		Check for leakage from hose and fittings.
	Exhaust gas is poisonous. Always operate the generator outdoors.		Fire, naked flame and smoking are prohibited.
	Stop the engine before refueling.		Hot, avoid touching the hot area.
	ON (RUN)		GASOLINE SP95 or SP98
	OFF (STOP)		Engine oil
	Alternating current		Top up with oil
	DC current		Choke (cold starting aid)
	HIGH SPEED		Plus : positive polarity
	IDLE		Minus : negative polarity
	START (Starting the engine)		Protective earth (ground)
	STOP (Stopping the engine)		Battery charging condition

2. SAFETY PRECAUTIONS

-  Do not operate the generator near gasoline or gaseous fuel because of the potential danger of explosion or fire.
-  Do not fill the fuel tank with fuel while the engine is running. Do not smoke or use a naked flame near the fuel tank. Be careful not to spill fuel during refueling. If fuel is spilt, wipe it off and let dry before starting the engine.
-  Do not place inflammable near the generator. Be careful not to place fuel, matches, gunpowder, oily cloths, straw, trash, or any other in flammables near the generator.
-  Do not operate the generator inside a room, cave, tunnel, or other insufficiently ventilated area. Always operate it in a well-ventilated area, otherwise the engine may become overheated, and the poisonous carbon monoxide gas contained in the exhaust gases will endanger human lives. Keep the generator at least 1 meter (3 feet) away from any structure or building during use. If the generator must be used indoors, the area must be well-ventilated and extreme caution must be taken regarding the discharge of exhaust gases. Failure to follow the correct procedures can be fatal.
-  Do not enclose the generator nor cover it with a box. The generator has a built-in forced air cooling system, and may become overheated if it is enclosed. If generator has been covered to protect it from the weather during non use, be sure to remove it and keep it well away from the area during generator use.
-  Operate the generator on a level surface. It is not necessary to prepare a special foundation for the generator. However, the generator will vibrate on an irregular surface, so choose a level place without surface irregularities. If the generator is tilted or moved during operation, fuel may spill and/ or the generator may tip over, causing a hazardous situation. Proper lubrication cannot be expected if the generator is operated on a steep incline or slope. In such a case, piston seizure may occur even if the oil level is above the minimum level.
-  Pay attention to the wiring or extension cords from the generator to the connected device. If the wire is under the generator or in contact with a vibrating part, it may break and possibly cause a fire, generator burnout, or electric shock hazard. Replace damaged or worn cords immediately.
-  Do not operate in rain, in wet or damp conditions, or with wet hands. The operator may suffer severe electric shock if the generator is wet due to rain or snow.
-  If the generator is wet, wipe and dry it before starting. Do not pour water directly over the generator, never wash it with water.
-  Be extremely careful that all necessary electrical grounding procedures are followed during each and every use. Failure to do so can be fatal.
-  Do not contact the generator to a commercial power line. Connection to a commercial power line may short circuit the generator and ruin it or cause electric shock hazard. Use the transfer switch for connecting to domestic circuit. In the special case where the generator will be connected as stand by to the commercial network, the installation must be carried out by a qualified electrician taking into account the technical specifications of the generator and the commercial network.

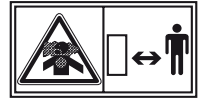



No smoking while handling the battery. The battery emits flammable hydrogen gas, which can explode if exposed to electric arcing or a naked flame. Keep the area well-ventilated and keep naked flames/sparks away when handling the battery.



Engine becomes extremely hot during and for some time after operation. Keep combustible materials well away from generator area. Be very careful not to touch any parts of the hot engine especially the muffler area or serious burns may result.



Keep children and all bystanders at a safe distance from work areas.



It is absolutely essential that you know the safe and proper use of the power tool or appliance that you intend to use. All operators must read, understand and follow the tool/appliance owners manual. Tool and appliance applications and limitations must be understood. Follow all directions given on labels and warnings. Keep all instruction manuals and literature in a safe place for future reference.



Use only «Homologated» extension cords according to CEI 245-4. When a tool or appliance is used outdoors, use only extension cords marked «For Outdoor Use». Extension cords, when not in use should be stored in a dry and well ventilated area.



Always switch off generator's circuit breaker and disconnect tools or appliances when not in use, before servicing, adjusting, or installing accessories and attachments.

3. SPECIFICATIONS

	SILENTSTAR					
	7 M AVR YN	7 T AVR YN	11000D M AVR YN	11000D T AVR YN	13000D M AVR YN	13000D T AVR YN
COP Power 230V (cosφ=1)	5,5 kW	2,0 kW	9,7 kW	3,3 kW	11,2 kW	3,7 kW
LTP Power (cosφ=0,8)	-	6,1 kW / 7,6 kVA	-	9,9 kW / 12,4 kVA	-	11,4 kW / 14,3 kVA
Rated Output Power	5,5 kW	5,5 kW	8,8 kW	8,8 kW	10 kW	10 kW
Noise Power Level (Lwa)	86 dB	86 dB	96 dB	96 dB	95 dB	95 dB
Rated Power Factor	1	0,8	1	0,8	1	0,8
Rated Current	23,9 A	7,9 A	38,3 A	12,9 A	43,4 A	14,5 A
Nominal voltage	230 V single phase 400 V three phases 230 V single phase 400 V three phases 230 V single phase 400 V three phases					
Alternator type	Brushless, 2 poles					
Voltage regulator	AVR	AVR	AVR	AVR	AVR	AVR
Frequency	50 Hz					
Single socket 230V IP44 - 10/16A	1	1	1	1	1	1
Single socket 230V - 16A (CEE)	1	1	1	1	1	1
Single socket 230V - 32A (CEE)	1	-	1	-	1	-
Three socket 400V - 3P+T+N 16A	-	1	-	1	-	1
Access for remote and direct connection	Serial	Serial	Serial	Serial	Serial	Serial
Voltmeter	Serial	Serial	Serial	Serial	Serial	Serial
Frequencymeter	Serial	Serial	Serial	Serial	Serial	Serial
Hourmeter	Serial	Serial	Serial	Serial	Serial	Serial
Engine Model	3TNM72-GWG - YANIMAR					
Engine Type	3 cyl. in line 4T					
Cooling System	Liquid					
Maximum Output	9,8 HP - 1500 rpm					
Piston Displacement	904 cm ³		16,1 HP - 3000 rpm		19,2 HP - 3000 rpm	
Fuel	Diesel					
Fuel Tank Capacity	40 Liters					
Autonomy at 3/4 Load	30 h 30	30 h 30	17 h 00	16 h 30	13 h 50	13 h 30
Starting system	ELECTRICAL					
Electronic Oil Sensor	Serial					
Frame	Sound proof canopy - Double layer panel					
Dimensions LxIxH (mm)	1360 x 650 x 840 mm					
Packaging Dimensions LxIxH (mm)	1380 x 650 x 860 mm					
Dry Weight	396 kg	396 kg	393 kg	392 kg	393 kg	400 kg
Gross Weight	420 kg	420 kg	418 kg	417 kg	418 kg	425 kg

4. CONTROL PANEL

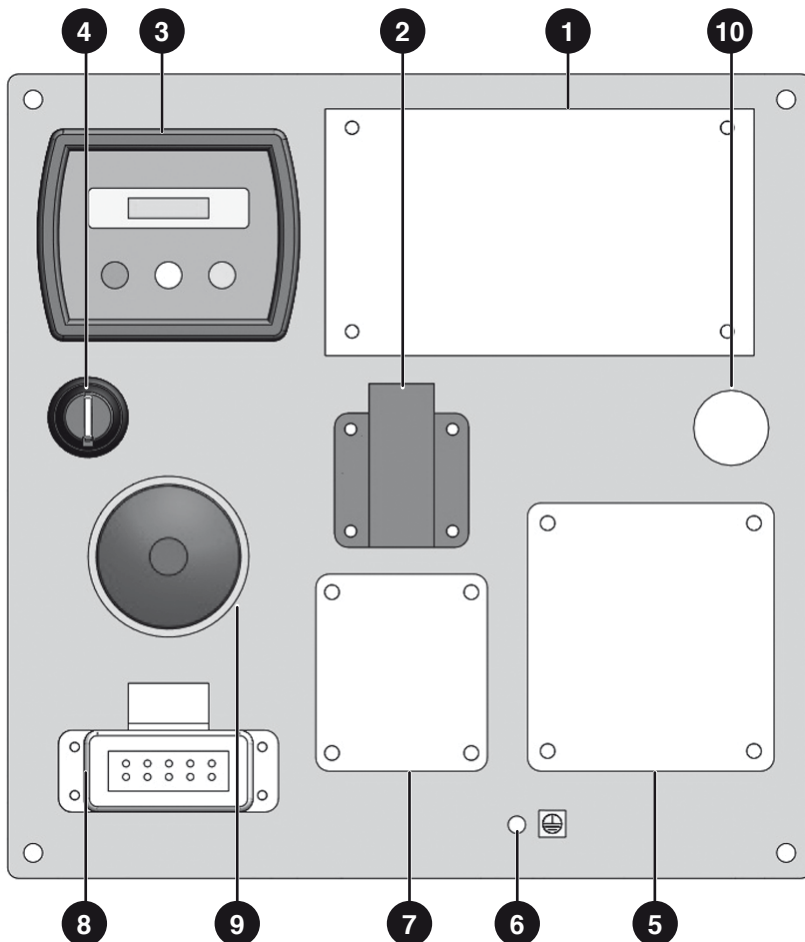

- | | |
|---|---|
| 1 Current leakage protection and circuit breaker | 6 Earth connection |
| 2 Single phase socket 230 V - 10/16 A SCHUKO | 7 Single phase socket 230V - 16A CEE |
| 3 Starting and Control Module (Frequencymeter / Voltmeter) | 8 Connection for additional options |
| 4 Key Switch | 9 Emergency Stop Button |
| 5 Single phase socket 230V – 32A – CEE or Three phase socket 400V – 3P + T + N - 16A | 10 Access for remote and direct connection |

5. PRE-OPERATION CHECK

CONTROL OF THE OIL ENGINE LEVEL

Before checking or refilling oil, be sure generator is located on stable and level surface with engine stopped.

- Check the oil level thanks to the gage (1)
- If the oil level is lower than the lower level (3), the engine must be filled with recommended oil (see sheet below) until the mark on the gage showing the maximum level (2).
- Unscrew the oil filler cap (4), refill with suitable oil (5)
- Screw again the cap by hand
- Replace the oil when this one is dirty.

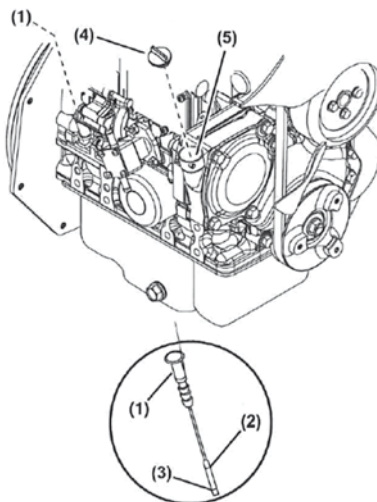

Oil Capacity	Lower/Upper Level
SILENTSTAR 7 M AVR YN	1.3 / 2.9 L
SILENTSTAR 7 T AVR YN	1.3 / 2.9 L
SILENTSTAR 11000D M AVR YN	1.5 / 3.2 L
SILENTSTAR 11000D T AVR YN	1.5 / 3.2 L
SILENTSTAR 13000D M AVR YN	1.7 / 3.7 L
SILENTSTAR 13000D T AVR YN	1.7 / 3.7 L

RECOMMENDED ENGINE OIL

Use class SE (API classification) oil or a higher grade oil according to the table below. SAE 10W-30 is recommended for general, all temperature use. If single viscosity oil is used, select the appropriate viscosity for the average temperature in your area.

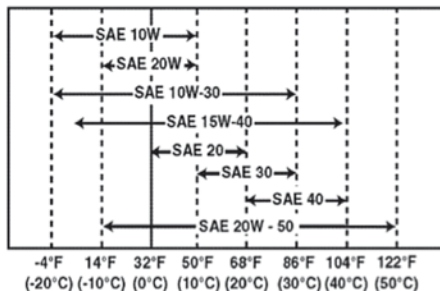

WARNING

Do not remove the fuel tank cap while the engine is running. Do not refuel while smoking or near naked flame or other such potential fire hazards. Otherwise fire accident may occur.

CHECK COOLING LIQUID

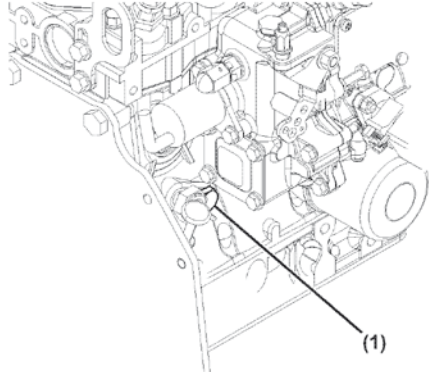
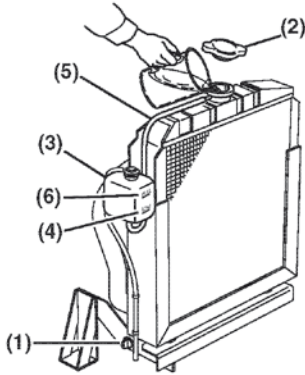

- When the engine is cold, make sure the drain cooling liquid cap (1) is well screwed.
 - Take out the oil filler cap (2) and fill the radiator with cooling liquid. Check that the cooling liquid level in the cooling liquid tank (3) is between the lower level written LOW (4) and the upper level written FULL (6), engine not running.
 - When the engine will be turned on, make sure that the cooling liquid level will be close to the upper level written FULL (6).
1. If the level is over the FULL mark, move out liquid thanks to the drain cap (1), when the engine is cold.
 2. If it is missing some cooling liquid, unscrew the oil filling cap (2), fill and adjust with clean liquid, when the engine is cold.

	Cooling System Liquid
SILENTSTAR 7 M AVR YN	5 L
SILENTSTAR 7 T AVR YN	
SILENTSTAR 11000D M AVR YN	
SILENTSTAR 11000D T AVR YN	
SILENTSTAR 13000D M AVR YN	
SILENTSTAR 13000D T AVR YN	

WARNING

Do never remove the cooling liquid cap (2) if the engine is hot or running. Let it cool and then fill it again.
Always make sure that the drain cooling liquid cap (1) is well screwed before starting the generator.

CHECK FUEL LEVEL

WARNING

Do not remove the fuel tank cap while the engine is running. Do not refuel while smoking or near naked flame or other such potential fire hazards. Otherwise fire accident may occur.

Check visually fuel level in the tank. If fuel level is low, refill with diesel. Do not forget to place a strainer fuel at the filling side of the tank before filling the tank.

Make sure the Diesel filter is filled. If there is not enough diesel, it is necessary to drain the air (see the part below).

	Diesel Tank Capacity
SILENTSTAR 7 M AVR YN	40 L
SILENTSTAR 7 T AVR YN	
SILENTSTAR 11000D M AVR YN	
SILENTSTAR 11000D T AVR YN	
SILENTSTAR 13000D M AVR YN	
SILENTSTAR 13000D T AVR YN	

PROCEDURE TO DRAIN THE AIR FROM THE DIESEL PIPES

WARNING

After the first starting or a stop due to lack of diesel, it is necessary to drain the air between the tank and the injection pump thanks to the lever (1) next to the mechanical pump, until the diesel filter cap is totally filled.

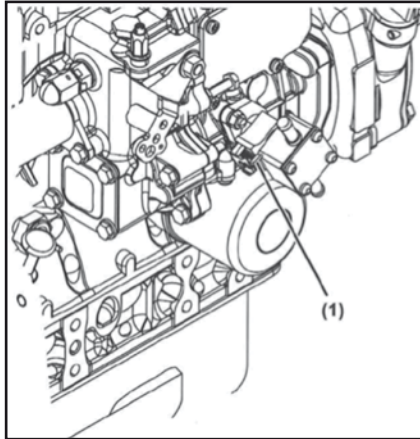

⚠ WARNING

- Make sure you review each warning in order to prevent fire hazard.
- Do not refill tank while engine is running or hot.
- Be careful not to admit dust, dirt, water or other foreign objects into fuel.
- Wipe off spilt fuel thoroughly before starting engine.
- Keep naked flames away.

CHECKING COMPONENT PARTS

Check following items before starting engine:

- Fuel leakage from fuel hose, etc;
- Leakage of cooling liquid or level of cooling liquid not enough;
- Leakage of oil close to the engine;
- Bolts and nuts for looseness;
- Components for damage or breakage;
- Generator not resting on or against any adjacent wiring;
- Damage of some hoses (air filter, cooling liquid, Diesel filter, water filter);
- Dust with the blade of the radiator;
- The functioning of the speed control lever;
- Status of the filters (air filters, Diesel filter, water filter);
- Control generator environment.

WARNING

- Make sure you review each warning in order to prevent fire hazard.
- Keep area clear of in flammables or other hazardous materials.
- Keep generator at least 3 feet (1 meter) away from buildings or other structures.
- Only operate generator in a dry, well ventilated area.
- Keep exhaust pipe clear of foreign objects.
- Keep generator away from naked flame. No smoking!
- Keep generator on a stable and level surface.
- Do not block generator air vents with paper or other material.

GROUNDING THE GENERATOR

- Before using the generator, the grounding lug on the panel must be connected to the earth.
- To ground the generator to the earth, connect the grounding lug of the generator to the grounding spike driven into the earth or to the conductor which has been already grounded to the earth.
- If such grounding conductor or grounding electrode is unavailable, connect the grounding lug of the generator to the grounding terminal of the using electric tool or appliance.

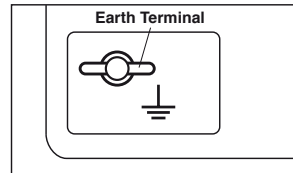

6. OPERATING PROCEDURES

WARNING

Before starting the generator:

- Check the oil level as explained before page 10. Do never move the accelerator lever adjusted in the manufactured plant
- Check the gasoline pipes are drained of the air bubble.

6.1. STARTING THE ENGINE

NOTE

All the information related to the display is written in the manual user book.

- Make sure the diesel filter and water filter are in “O” position..

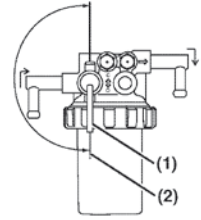

- Turn the key in “ON” position. During this time, the display turns on (see below the description of the display).



- Press “START” button **1** to start the engine and let it run for few minutes with no load.



FONCTION

DESCRIPTION

FONCTION	DESCRIPTION
1 START button	<ul style="list-style-type: none"> ● In manual mode : press to start the generator
2 AUTO button	<ul style="list-style-type: none"> ● Press to change to automatic mode
3 OFF / RESET button	<ul style="list-style-type: none"> ● Press to stop the generator when it is running ● Press to reset the alarms after a failure. ● Press 3 sec. to test the LED of the control panel
4 Scroll / Go down button	<ul style="list-style-type: none"> ● Press to scroll the menu ● Press to decrease the value during a setup.

6.2. DIFFERENT INFORMATION FROM THE GENERATOR DISPLAY

- It is possible to scroll down different information thanks to the button able to scroll the pages:
- Once chosen, the page will remain the display information until the user chooses another page.
- If an alarm is enabled, the display shows the problem with a symbol paying attention of the user.

Hereunder several options are visible on the display during the working time:

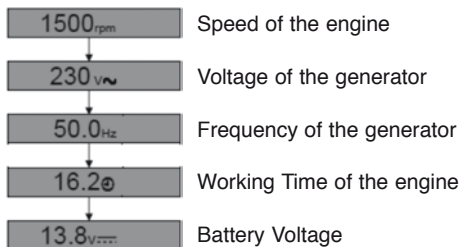

6.3. USING ELECTRIC POWER

AC APPLICATION

This generator is thoroughly tested and adjusted in the factory. If the generator does not produce the specified voltage, consult your nearest Worms dealer or service shop.

- Turn off the switch(es) of the electrical appliance(s) before connecting to the generator.
- Insert the plug(s) of the electrical appliance(s) into the receptacle.

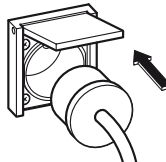

WARNING



Be sure to ground the generator if the connected electrical device is grounded.
Failure to ground unit could lead to electrical shock.

- Check the amperage of the receptacles, and be sure not to take a current exceeding the specified amperage.
- Be sure that the total wattage of all appliances does not exceed the rated output of the generator.

WARNING

Do not put foreign objects into the plug receptacle.

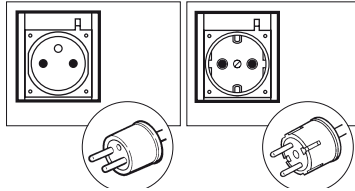

NOTE

When the circuit breaker or no-fuse breaker turns off during operation, the generator is overloaded or the appliance is defective. Stop the generator immediately, check the appliance and/or generator for overloading or detect and have repaired as necessary by Worms dealer or service shop.

7. STOPPING THE GENERATOR

1. Turn off the power switch of the electric equipment and unplug the cord from the receptacle of the generator.
2. Allow the engine about 3 minutes to cool down at no-load before stopping.
3. Press the OFF / RESET button  to stop the generator.
4. Turn the key switch to "OFF" position.



WARNING

The generator must always be stored in "OFF" position. If not, the risk is to unload the battery after a long term storage.

8. OIL SENSOR

- The oil sensor detects the fall in oil pressure in the crankcase and automatically stops the engine when the oil pressure falls below a predetermined value.
- When engine has stopped automatically, turn off the key switch of the generator, and check the oil level. Refill engine oil to the upper level (see the part 5. pre-operation check) and restart the engine.
- If the engine does not start by usual, consult your nearest Worms Entreprises dealer or service shop.

9. WATTAGE INFORMATION

Some appliances need a “surge” of energy when starting. This means that the amount of electrical power needed to start the appliance may exceed the amount needed to maintain its use. Electrical appliances and tools normally come with a label indicating voltage, cycles/Hz, amperage (amps) and electrical power needed to run the appliance or tool. Check with your nearest dealer or service center with questions regarding power surge of certain appliances or power tools.

- Electrical loads such as incandescent lamps and hot plates require the same wattage to start as is needed to maintain use.
- Loads such as fluorescent lamps require 1.2 to 2 times the indicated wattage during start-up.
- Loads for mercury lamps require 2 to 3 times the indicated wattage during start-up.
- Electrical motors require a large starting current. Power requirements depend on the type of motor and its use. Once enough “surge” is attained to start the motor, the appliance will require only 30% to 50% of the wattage to continue running.
- Most electrical tools require 1.2 to 3 times their wattage for running under load during use. For example, a 5,000 watt generator can power a 1800 to 4000 watt electrical tool.
- Loads such as submersible pumps and air compressors require a very large force to start. They need 3 to 5 times the normal running wattage in order to start. For example, a 5,000 watt generator would only be able to drive a 1,000 to 1,700 watt pump.

NOTE

The following wattage chart is general guide only. Refer to your specific appliance for correct wattage. To determine the total wattage required to run a particular electrical appliance or tool, multiply the voltage figure of the appliance/tool by the amperage (amps) figure of the same appliance / tool. The voltage and amperage (amps) information can be found on a name plate which is normally attached to electrical appliances and tools.

	SILENTSTAR		
	7 M AVR YN	7 T AVR YN	11000D M AVR YN
Bulb / Halogen / Heating	5500 W	1800 W / phase	8800 W
Neons - Low consumption Bulb	5500 W	1800 W / phase	8800 W
Hand Tools without variator	3500 W	1200 W / phase	5500 W
Compressor	1800 W	600 W / phase	2900 W
Electric Moteur Without Load	4,9 HP / 3,7 kW	4,9 HP / 3,7 kW	7,8 HP / 5,9 kW
Welder	130 A maxi	130 A maxi	130 A maxi

	SILENTSTAR		
	11000D T AVR YN	13000D M AVR YN	13000D T AVR YN
Bulb / Halogen / Heating	3000 W / phase	10000 W	3500 W / phase
Neons - Low consumption Bulb	3000 W / phase	10000 W	3500 W / phase
Hand Tools without variator	1900 W / phase	6300 W	2200 W / phase
Compressor	1000 W / phase	3500 W	1200 W / phase
Electric Moteur Without Load	8,0 HP / 5,9 kW	8,9 HP / 6,7 kW	9,0 HP / 6,9 kW
Welder	130 A maxi	130 A maxi	130 A maxi

AVR CONTROL	
Voltage regulating	± 2 %

NB : Calculations based on the continuous power (COP)

VOLTAGE DROP IN ELECTRIC EXTENSION CORDS

When a long electric extension cord is used to connect an appliance or tool to the generator, a certain amount of voltage drop or loss occurs in the extension cord which reduces the effective voltage available for the appliance or tool.

The chart below has been prepared to illustrate the approximate voltage loss when an extension cord of 300 feet (approx. 100 meters) is used to connect an appliance or tool to the generator.

Nominal Cross	No. A.W.G.	Allowable Current	Nb./ Ø	Resistance	(A)								Voltage drop
					1 A	3 A	5 A	8 A	10 A	12 A	15 A		
mm ²	N°	A	N°/mm	/100m	1 A	3 A	5 A	8 A	10 A	12 A	15 A		
0,75	18	7	30/0.18	2,477	2,5V	8V	12V	-	-	-	-		
1,27	16	12	30/0.18	1,486	1,5V	5V	7,5V	12V	15V	18V	-		
2,0	14	17	37/0.26	0,952	1V	3V	5V	8V	10V	12V	15V		
3,5	12 à 10	23	45/0.32	0,517	-	1,5V	2,5V	4V	5V	6,5V	7,5V		
3,5	10 à 8	35	70/0.32	0,332	-	1V	2V	2,5V	3,5V	4V	5V		

10. MAINTENANCE SCHEDULE

NOTE

- Maintenance operations require trained and qualified personnel.
- The maintenance schedule is given as a guide. Under severe conditions, the frequency of maintenance must be increased.
- Before changing the oil, check for a suitable way to dispose of the old oil. Do not pour it down sewage drains, onto garden soil or into open streams. Your local zoning or environmental regulations will give you more detailed instructions on proper disposal.

Every 50 h	<ul style="list-style-type: none"> ● Drain the diesel and water filter. ● Check the load of the battery.
Every 250 h	<ul style="list-style-type: none"> ● Drain the diesel from the tank. ● Clean the oil of the engine and replace the oil filter. ● Control and clean the blades of the radiator. ● Control the belt of the radiator. ● Adjust the speed control of the engine. ● Clean the air cleaner paper element.
Every 500 h	<ul style="list-style-type: none"> ● Replace air cleaner paper element. ● Replace the diesel filter. ● Clean the water filter. ● Clean and Remove carbon from cylinder head and the top of the cylinder. ● Check the mount rubbers of the engine.
Every 1000 h	<ul style="list-style-type: none"> ● Drain, clean, and fill again the radiator with clean cooling liquid ● Inspect control panel parts. ● Check rotor and stator. ● Check and adjust valve clearance.
Every 1500 h	<ul style="list-style-type: none"> ● Inspect, clean and test injectors if necessary. ● Check the breather.
Every 2000 h	<ul style="list-style-type: none"> ● Replace the fuel and cooling liquid hoses. ● Check and adjust valve clearance.

11. “HOW-TO” MAINTENANCE

11.1. ENGINE OIL CHANGE

Change engine oil every 250 hours. (For new engine, change oil after 50 hours.)

DANGER

Fire forbidden.

- Place a receptacle under the drain oil.
- Unscrew the oil drain plug (1).
- Take out the oil drain pipe (2).
- Open the drain valve (3).
- Wait that the complete quantity of oil fell into the receptacle.
- Close the drain valve (3).
- Place back inside the oil drain pipe (2).
- Screw again the oil drain plug (1).

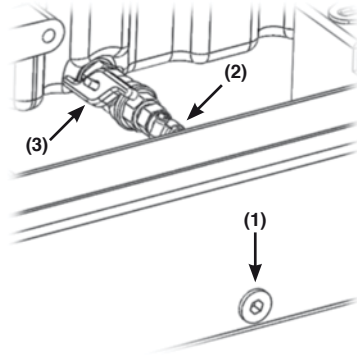

Use fresh and high quality lubricating oil to the specified level. If contaminated or deteriorated oil is used or the quantity of the engine oil is not sufficient, the engine damage will result and its life will be greatly shortened.

11.2. SERVICING THE AIR CLEANER

11.2.1 PRESENTATION AND OPENING THE AIR FILTER

Maintaining an air cleaner in proper condition is very important. Dirt induced through improperly installed, improperly serviced or inadequate elements damages and wears out engines. Keep the element always clean.

- Turn the air filter cover and take out the 2 air filter elements (1):

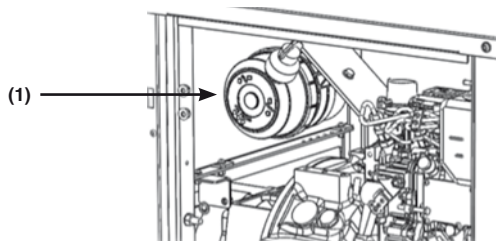

The air filter has 2 elements: one main element in carton (2) and a second one with a special tissue, a central cylinder in plastic material, and one radial seal in polyurethan foam (3).

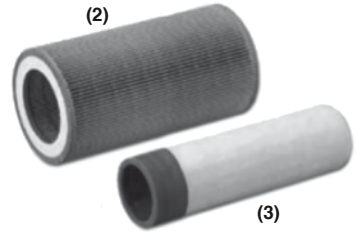

- Then, put back the filter elements inside the plastic air filter after maintenance or replacement. Be careful to place them correctly inside, in order for the seals to work perfectly.
- Turn back the plastic cover.

11.2.2 PROCESS OF MAINTENANCE

Maintenance of the filter is necessary when the filtering element is dirty. For that purpose, it is advisable to observe important rules:

- For the cleaning, place a tube on an air pistol, the extremity of which is roughly 90°. The tube must be enough long to reach the bottom of the filtering element. Clean with precaution the filter element with some dry compressed air (5 bars max.), from the inside towards the outside or from the filtered side towards the not filtered side, until it appears no more dust. The top of the tube does not have to be in contact with the element (see below).

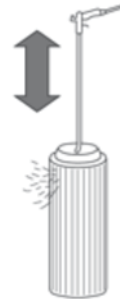

- Then, examine carefully the filtering element and verify the absence of damage.
- Never take out the dust by typing the filtering element, the risk is to damage it and then also the risk to damage the engine.
- The second element must never be cleaned, but must be replaced.
- After the maintenance of the filtering element, clean carefully inside the plastic filter and the seal with a wet cloth. During this operation, make sure no dust penetrates into and on the side of the air filter.

The cleaning has to be made every 250 hours and the 2 filtering elements must be changed every 500 hours.

Clean and change more often the 2 elements if the engine is used in dusty environment.

Check that the hose connecting the engine to the air filter is fixed well and that it is not damaged: If yes, it could happen the passage of dusts directly in the engine.

11.3. CHECK BATTERY VOLTAGE

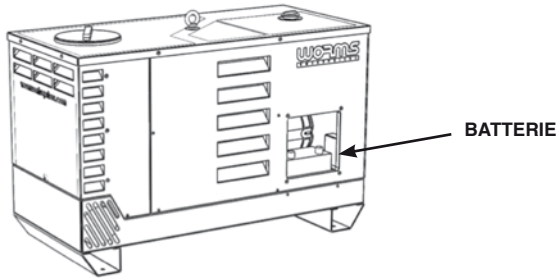

11.4. DRAIN THE COOLING PIPES

The pipes of the cooling liquid must be drained, cleaned and filled every 1000 hours of working.

- Place a receptacle under the engine to get the used cooling liquid.
- Unscrew the drain cooling liquid cap (1).
- Screw the cap once the drain completed.

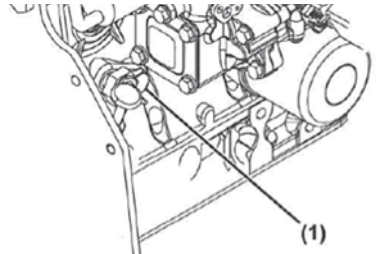

11.5. DRAIN AND REPLACEMENT OF THE WATER AND DIESEL FILTER

The water and diesel filter must be changed every 500h.

- Close the cock, "O" position to "C" position (5)
- Unscrew only the nut (1) of the water filter or the diesel filter.
- Clean the cup (3) and/or change the cartridge inside (4).
- Open again the cock, "C" position to "O" position (5).

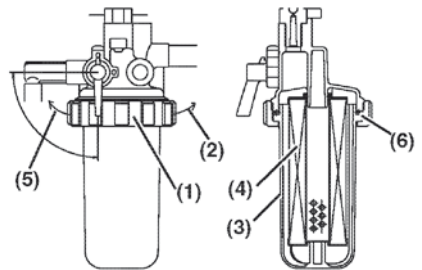

12. PREPARATION FOR STORAGE

The following procedures should be followed prior to storage of your generator for periods of 6 months or longer:

- Drain fuel from fuel tank carefully by disconnecting the fuel line. Diesel left in the fuel tank will eventually deteriorate making engine-starting difficult.
- Change engine oil.
- Check for loose bolts and screws, tighten them if necessary.

- Clean generator thoroughly with oiled cloth. Spray with preservative if available.
- Disconnect the – battery to avoid unload of the battery.

NEVER USE WATER TO CLEAN YOUR GENERATOR.

Stock the generator in a well ventilated and low humidity area.

13. TROUBLESHOOTING

When generator engine fails to start after several attempts, or if no electricity is available at the output socket, check the following chart.

If your generator still fails to start or to generate electricity, contact your nearest Worms Entreprises dealer shop for further information or corrective procedures.

WHEN ENGINE FAILS TO START:

Check fuel level.	If empty, refill fuel tank making sure not to overfill.
Check if the key switch of the engine is in the good position.	Turn the key switch to “ON” position and then press Start button I on the display.
Check to make sure generator is not connected to an appliance.	If connected, turn off the power switch on the connected appliance and unplug.
Check the voltage of the battery	Must be over 12V.
Check if the supply wires of the fuel solenoid and the oil sensor are well connected.	Reconnect the wires if necessary.

WHEN NO ELECTRICITY IS GENERATED AT RECEPTACLE:

Check to make sure no-fuse breaker is in the “I” (ON) position.	After making sure that the total wattage of the electrical appliance is within permissible limits and there are no defects in the appliance, turn the no-fuse breaker to the “I” (ON) position. If breakers continue to actuate, consult your nearest servicing dealer.
Check AC terminals for loose connection.	Secure connection if necessary.
Check to see if engine starting was attempted with appliances already connected to generator.	Turn off switch on the appliance, and disconnect cable from receptacle. Reconnect after generator has been started properly.

MU_02GE_SILENTSTAR_7k_11k_13k_AVR_YN_EN

WORMS
ENTREPRISES

Siège social / Head Office

ZAC de Lamirault
39 rue de Lamirault, 77090 Collégien, FRANCE
TEL. +33 (0) 1 64 76 29 50
FAX +33 (0) 1 64 76 29 99

Service SAV et Garantie

After Sales and Warranty Service
TEL. +33 (0) 1 64 76 29 80
FAX +33 (0) 1 64 76 29 88